



Algal Blooms

AN ECONOMIC PERSPECTIVE

Brad Bass
School of the Environment
University of Toronto



SCHOOL OF THE ENVIRONMENT



UNIVERSITY OF TORONTO
FACULTY OF ARTS & SCIENCE



Land Acknowledgement & Statement of Reconciliation

- The City of Mississauga is located on lands which are part of the Treaty and Traditional Territory of the Mississaugas of the Credit First Nation, The Haudenosaunee Confederacy, and The Huron-Wendat and Wyandot Nations.
- The settlement and growth of the City was made possible with the signing of Treaties over 200 years ago. First Nations, Inuit and Métis inherent and treaty rights are embedded in Canada's Constitution.
- We acknowledge that Reconciliation is about renewing our relationship with Indigenous Peoples to address past wrongs and respect legal rights.

Where are we going now?

- Overview leading up to 2008
- Complexity is an engineering issue
- Complexity requires a scientific understanding
- Complexity requires an economic approach
- Putting it into context

Overview



Lake Erie 1970



Sewage discharged into Lake Erie in 1966. Courtesy of Cleveland State Library Collections.



The Great Lakes Water Quality Agreement – *centerpiece of action*

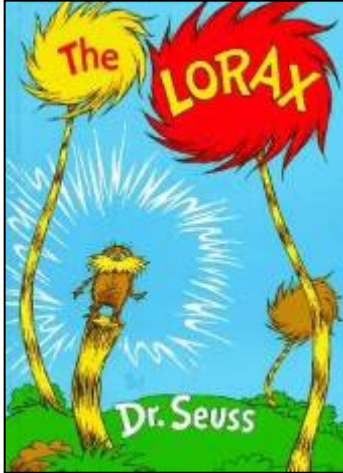

You're glumping the pond where the Humming-Fish hummed!
No more can they hum, for their gills are all gummed.
So I'm sending them off. Oh, their future is dreary.
They'll walk on their fins and get woefully weary
in search of some water that isn't so smeary.
I hear things are just as bad up in Lake Erie.

— *The Lorax*, by Dr. Seuss



Point sources were the primary focus...

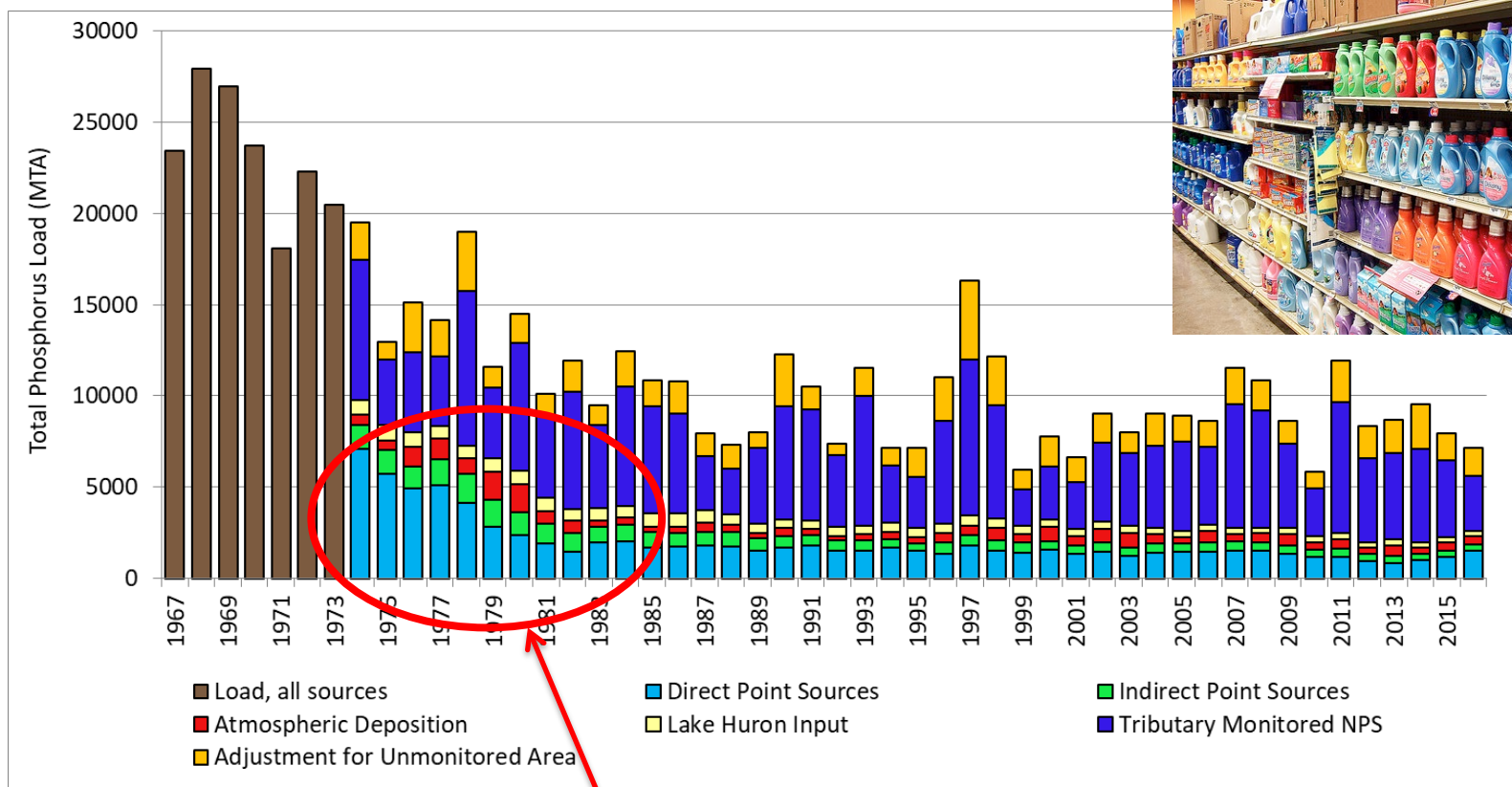

WWTP regulations put in place

Ontario's agricultural heartland

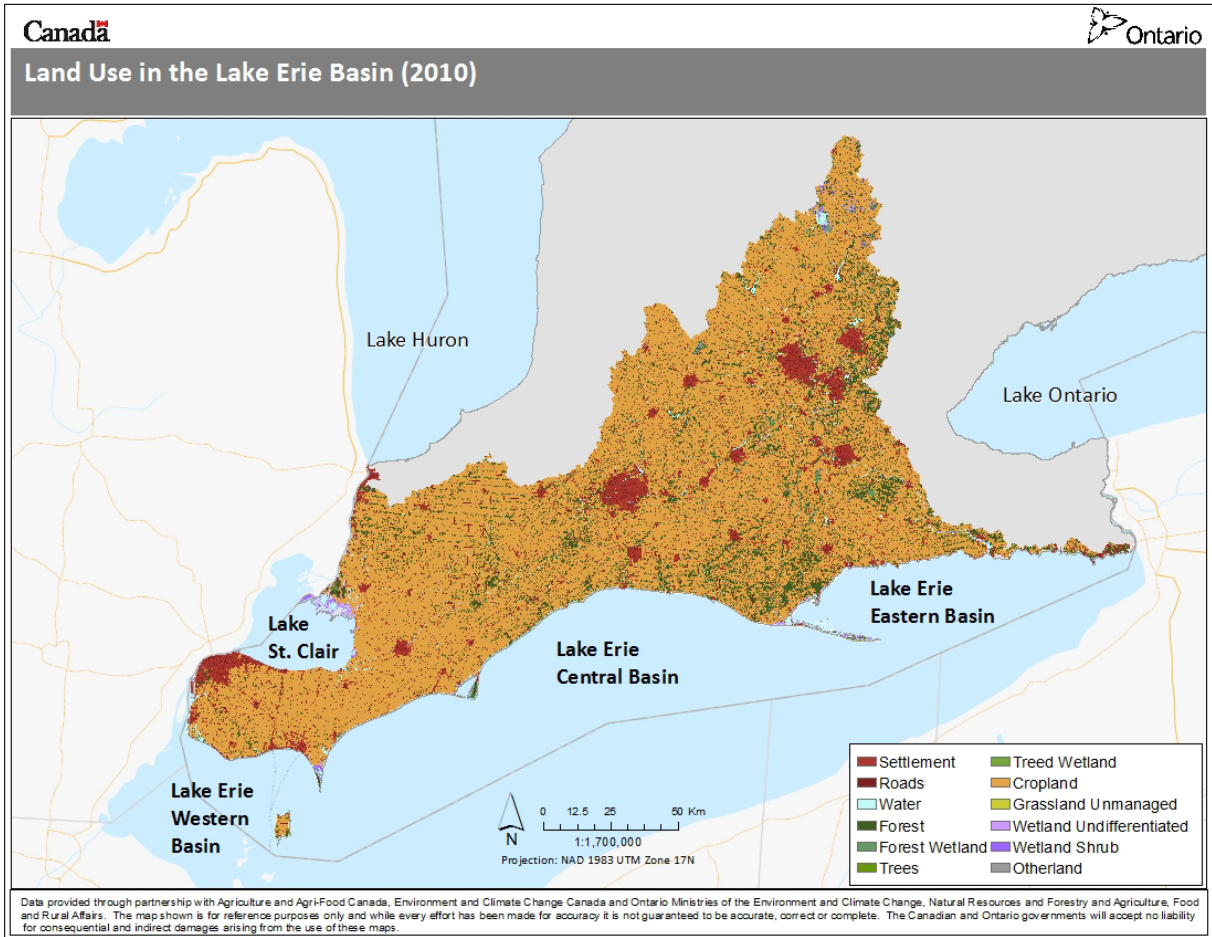

New Factors at Play

- **Population growth and land use changes**
 - Changes in phosphorus discharges from urban and agricultural landscapes due to changes in land use and land management practices
- **A changing climate**
 - increased frequency of severe storms
 - increased temperatures
 - longer growing seasons
- **Ecosystem changes - aquatic invasive species**
 - changes to water clarity and nutrient flows caused by Zebra and Quagga mussels
- **Bioavailable phosphorus increasing**
 - linkages to above factors



Plumes, blooms, and hypoxia



Evolution of my Thinking

- In 2008 I saw this as a technological issue
 - My role was to design the technology
 - Find ways to link this technology with other technologies
 - Complexity arising from replicating natural processes in technologies
-

Prototype Designer Ecosystem – Vertical Wetland

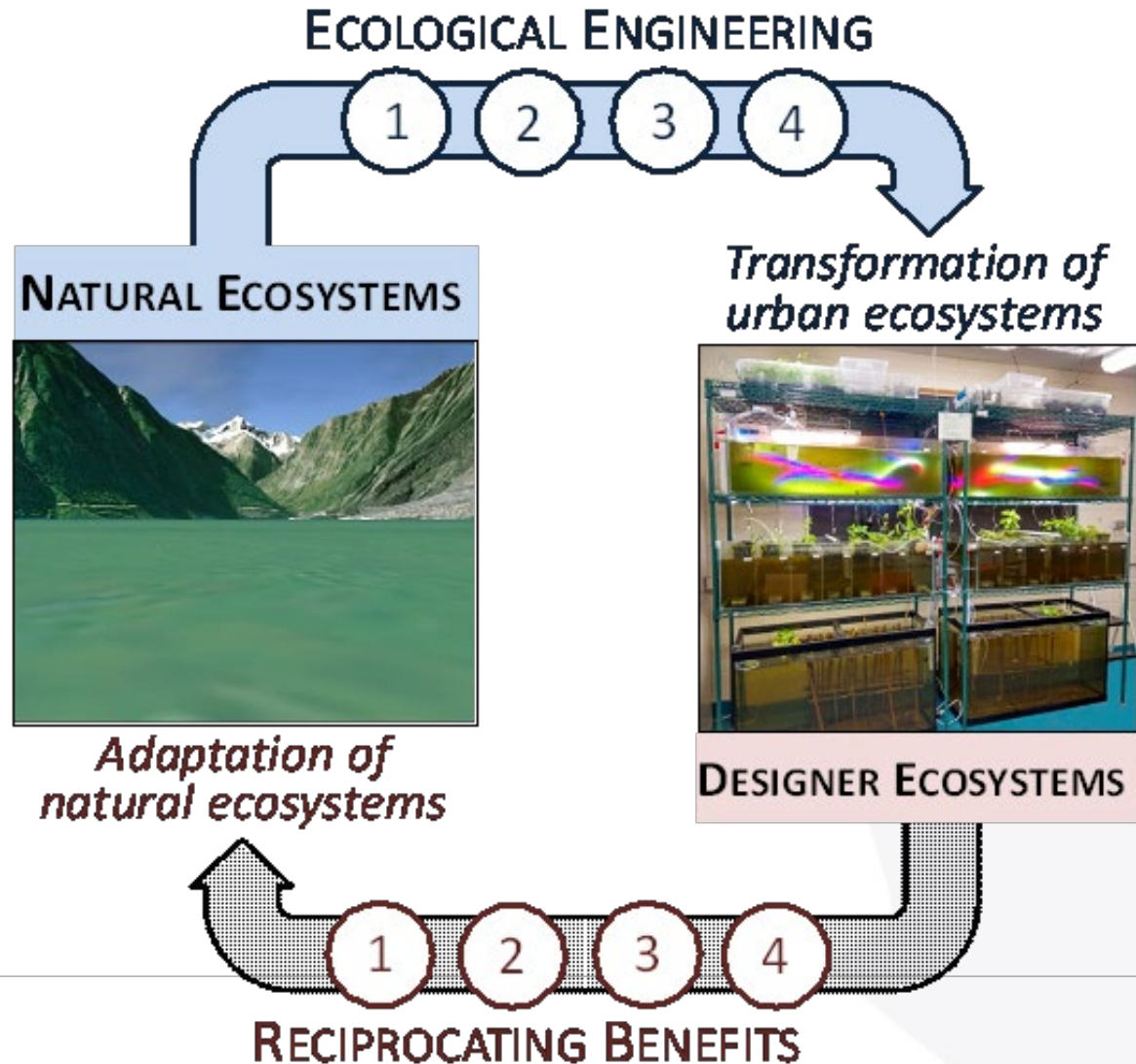

Model for Energy Transfer within Constructed Vertical Flow Wetland

Tick: 57264 Stop at Stop Speed:

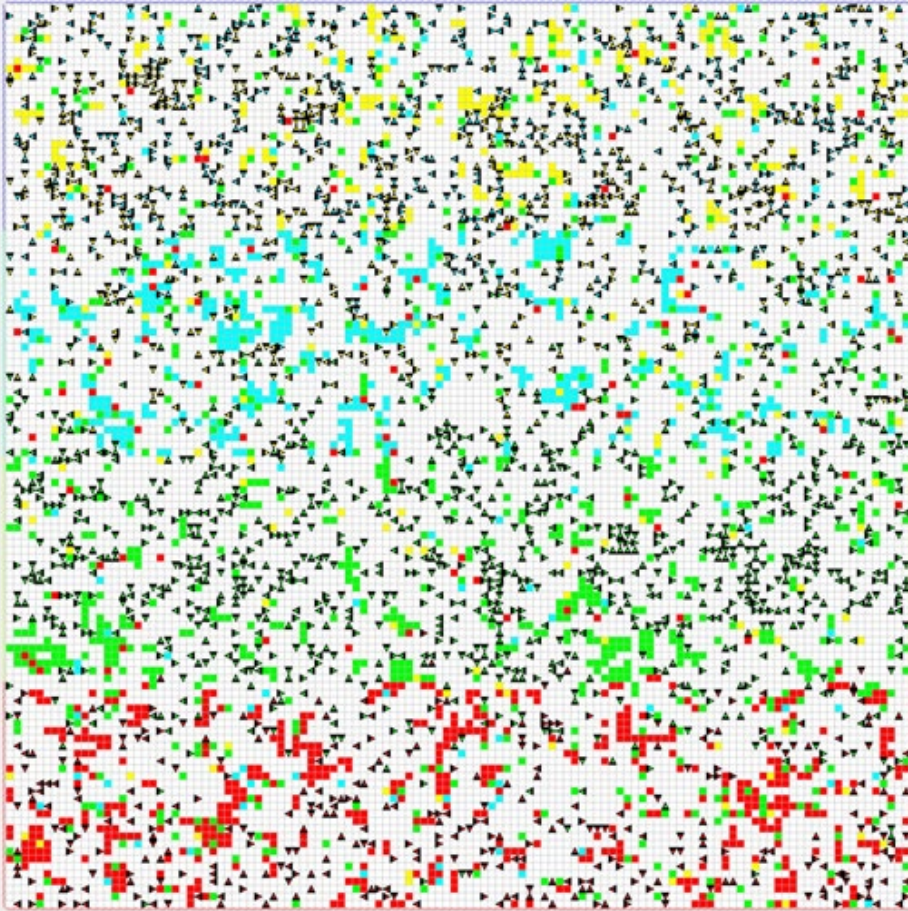

Tick: 57453 Stop at Stop Speed:

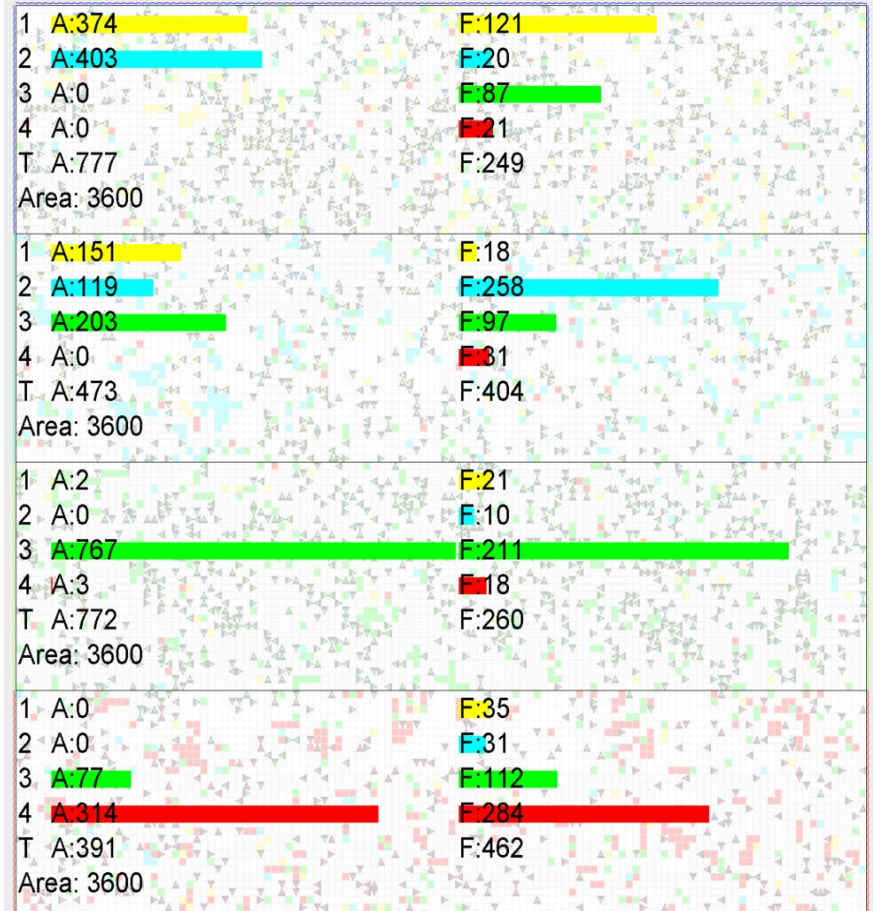

New Design for All-Season Constructed Vertical Flow Wetland

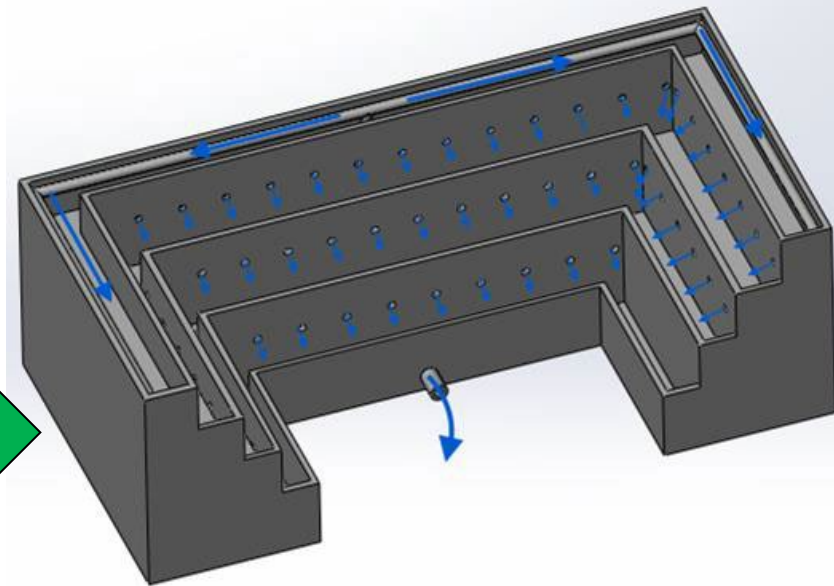
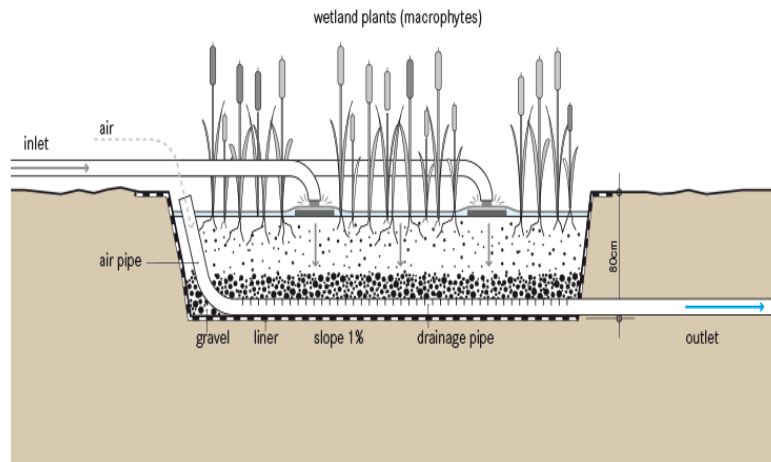

- Nicole Beasley, Cameron Fischer, Helen Liu, Dietrich Maahs, Terra MacMillian, Heather MacRae, Madison Mantha, Dylan Patterson and Julia Robinson

Can Zebra Mussels be a Resource?



Estimated Growth of the North American Green Roof Industry

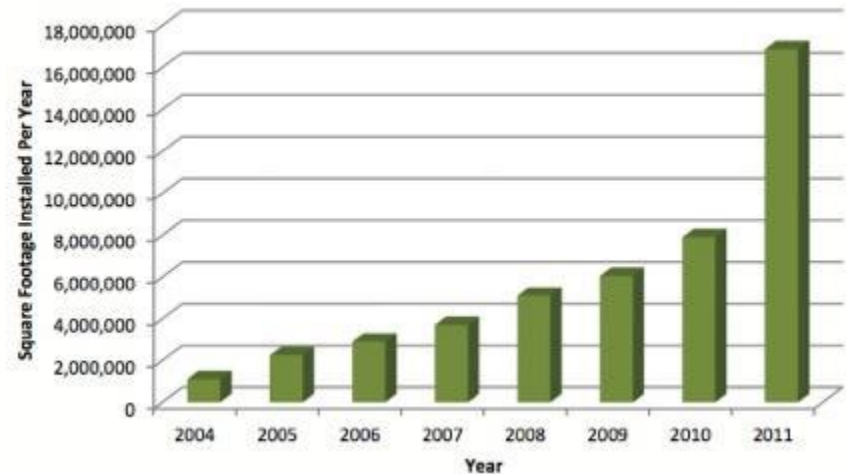

Best Management Practices



Cover crops



Fragile Land Retirement



Best Management Practices Effectiveness (literature review)

No	BMP	Type	PP reduction (%)	DP reduction (%)	TP reduction (%)
1	Cover crop	Non-structural	-17 (one data point)	-221 to 67	-160 to 92
2	Conservation tillage	Non-structural	15 to 93.4	-889 to 167	-47 to 97
3	Manure incorporation	Non-structural	-4.8 to 4.4	7.1 to 99	8 to 94
4	Fragile land retirement	Non-structural	73 to 97	3.6 to 39	17 to 97
5	Crop nutrient planning	Non-structural	-57 to 85	-171 to 92	-3.4 to 93
6	Adding organic amendment	Non-structural	No data	No data	No data
7	Reducing soil compaction	Non-structural	No data	No data	69 to 99
8	Controlled tile drain	Structural	No data	40 to 69	25 to 66
9	Grassed waterway	Structural	14 to 45	-487.6 to 22	0 to 67
10	Vegetative filter strip	Structural	36 to 92.4	-250 to 94.3	2 to 93
11	Windbreak	Structural	No data	No data	25 (wind related)
12	WASCoB	Structural	No data	No data	20 to 85
13	Wetland restoration	Structural	-277 to 87	-72 to 94	-422 to 99
14	Riparian buffer	Structural	63 to 84	27.6 to 99	2 to 97.4

Evolution of my Thinking

- In 2008 I saw this as a technological issue
 - Complexity arising from replicating natural processes in technologies

2013

- Complexity arising from
 - Scientific understanding
 - Linkages between different spatial scales
 - Interaction between climate and management on the land
-

Why are there large uncertainties

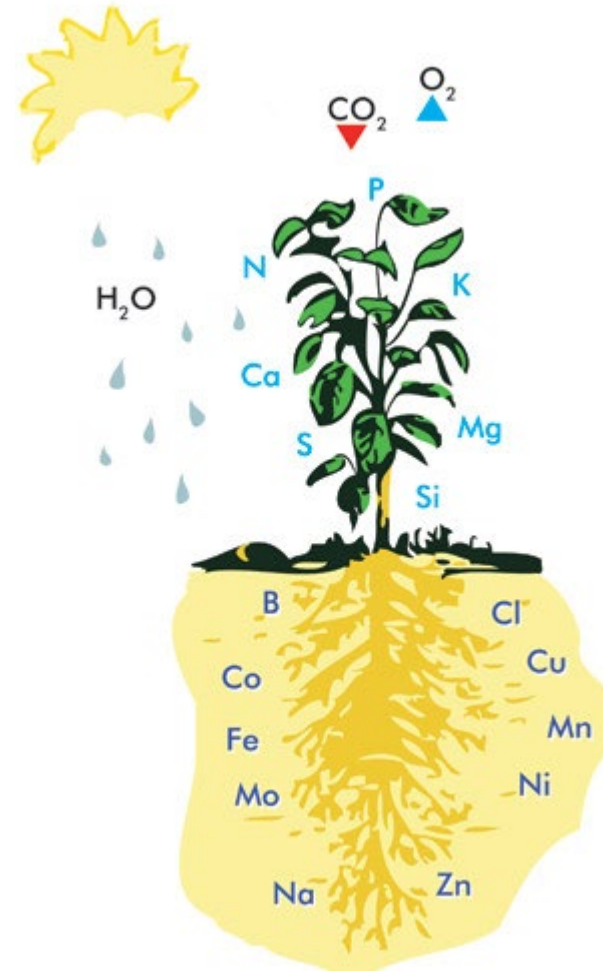
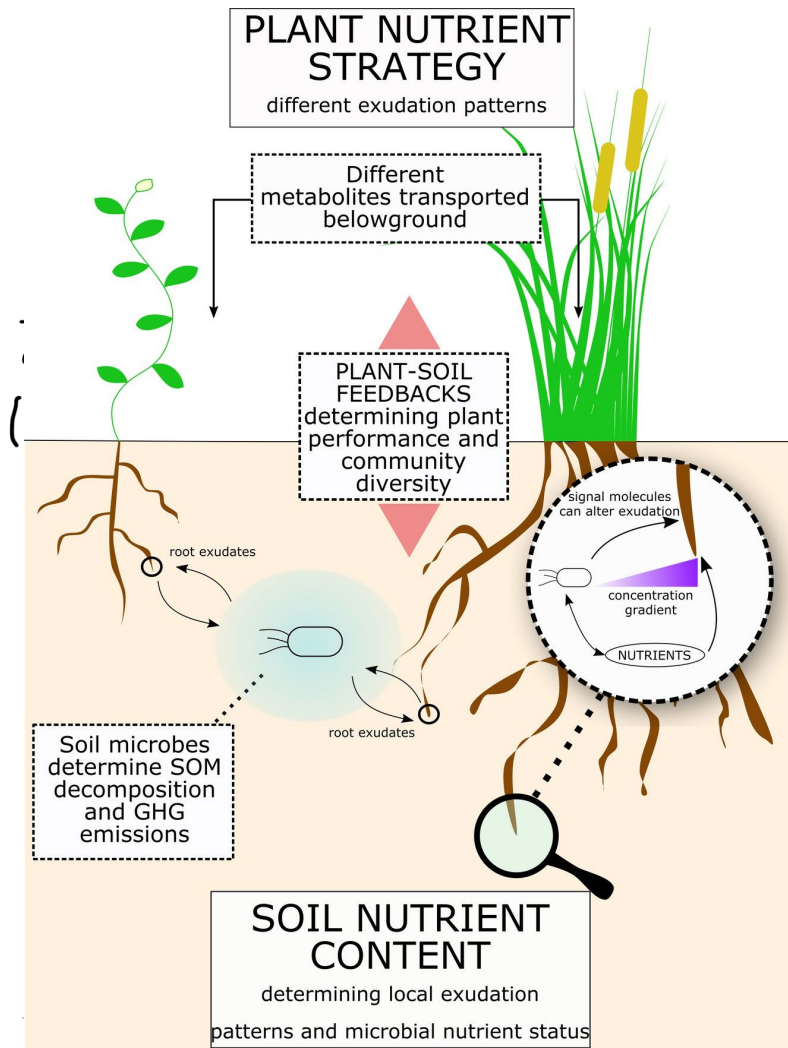

It's complicated!

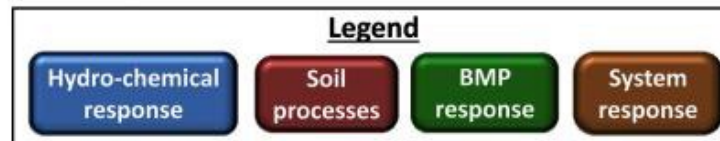

Source: Sharpley et. al, 2013. *Phosphorus Legacy: Overcoming the Effects of Past Management Practices to Mitigate Future Water Quality Impairment*. Journal of Environmental Quality. doi:10.2134/jeq2013.03.0098

What is the right Scale for Management? Cognitive Map of Ecosystem Dynamics

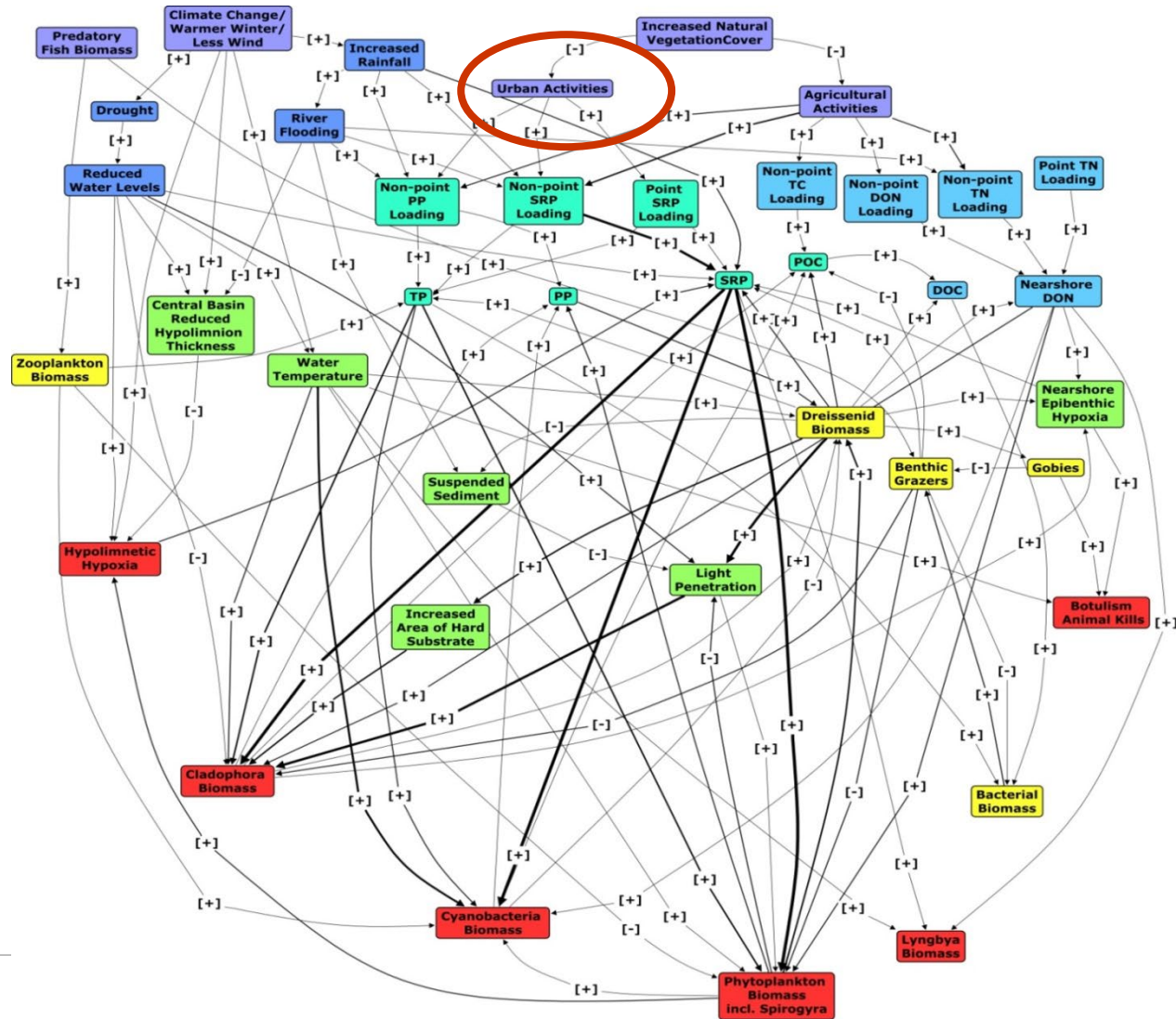

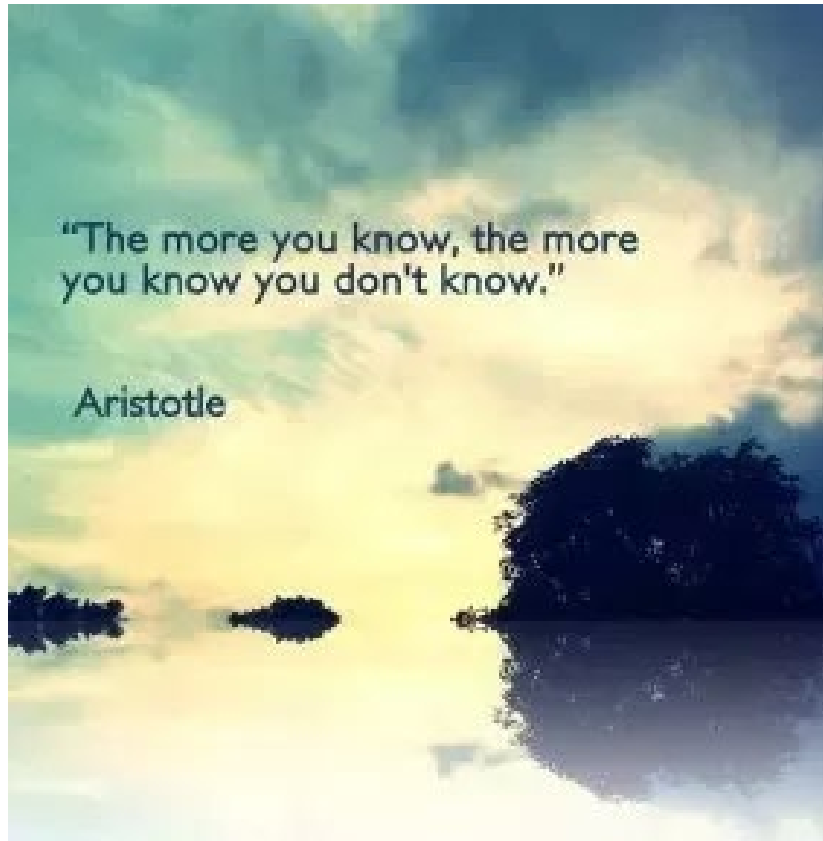

Evolution of my Thinking

- In 2008 I saw this as a technological issue
 - Complexity arising from replicating natural processes in technologies

2015

- Complexity arising from
 - Impact of social and economic factors on adoption of new management practices
 - Scientific understanding
 - Linkages between different spatial scales
 - Interaction between climate and management on the land
-

How much does this cost?

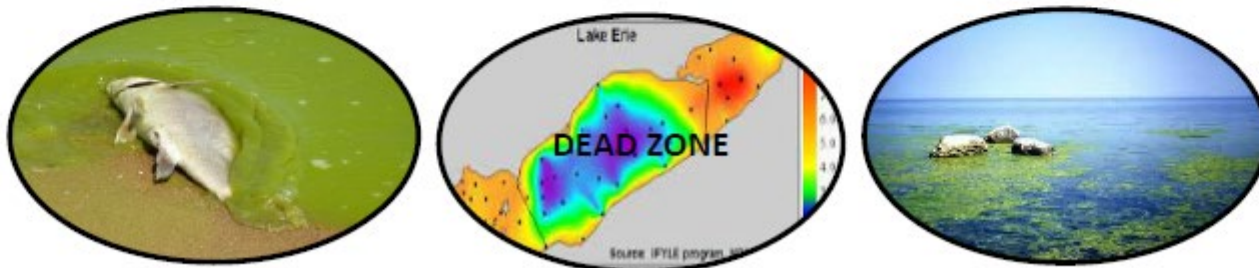
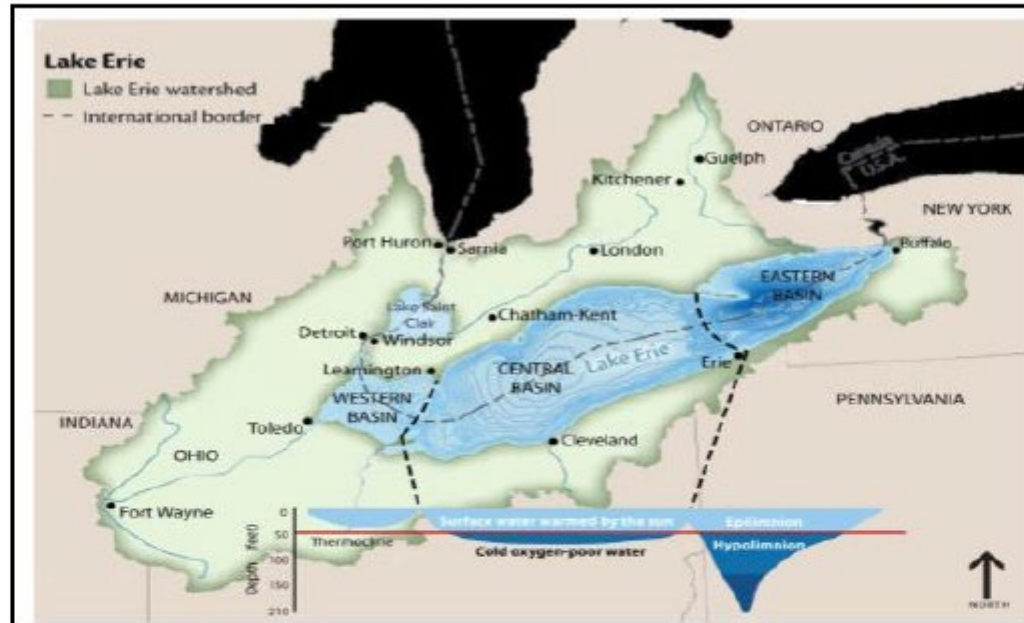

WEST



EAST

Before you start: Do you want to be an economist or an accountant?

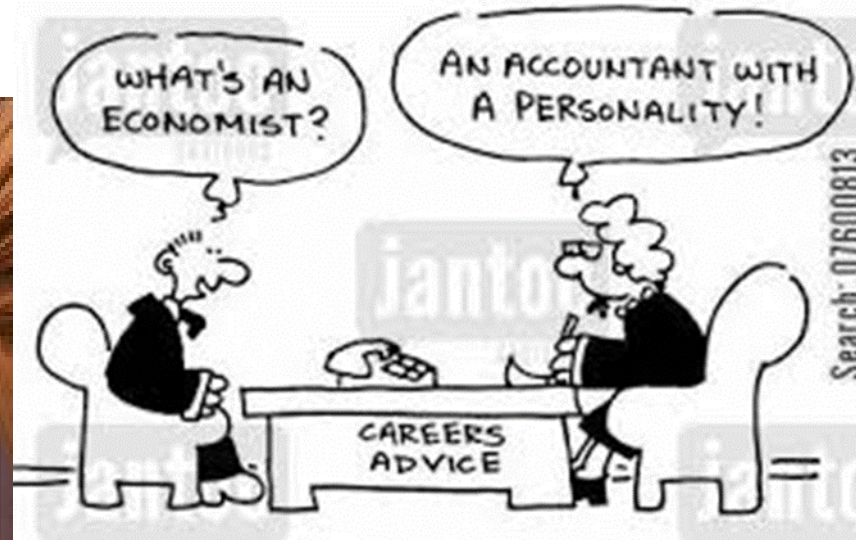

Before you start: economist or accountant?

Economist

- Responses to price signals
- Measure social welfare
- Money is a metric of social welfare
- More effort in valuation of non-market goods and services
- Questions impact of blooms on social welfare

Accountant

- Details of revenues & expenditures
- Measure stocks & flows
- Money is the primary measure of stocks & flows
- Less effort in valuation of non-market goods and services
- Questions impact of blooms on bottom line

Economic Analyses

- Direct costs to economy of algal blooms
 - Loss of well-being
- Secondary costs of algal blooms
 - GDP/Gross Output, Wages, Employment
- Cost-benefit analysis of different Best Management Practices (BMPs)
- Stimulus effect of widespread BMP adoption

Secondary costs

Direct Costs

- Social costs imposed upon those who use Lake Erie`s EGS

Secondary Costs

- Indirect costs measure impact on those who do business with directly affected sectors/people
 - Induced costs reduction in spending due to reduction in income
-

How do we assess the value

Framework for Integrated Assessment and Valuation of Ecosystem Goods and Services

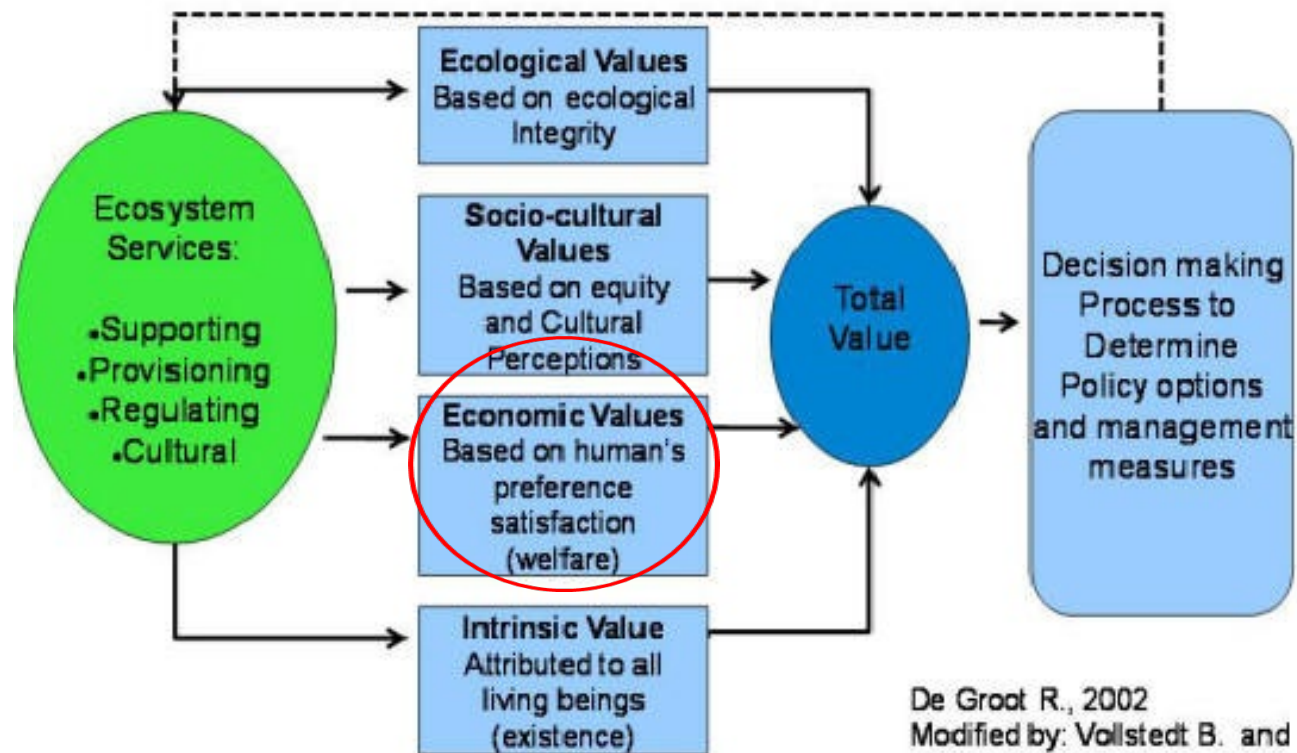

De Groot R., 2002
Modified by: Vollstedt B. and
Graterol R.

Valuation of Surface Water Quality Change

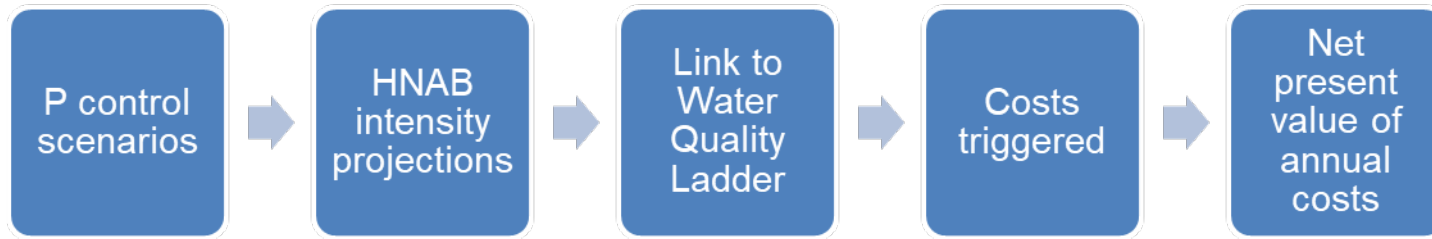

(1) Proposed Regulation/Policy/Project
eg. Mining related, limiting effluent of "X"

"Change" refers to the difference between policy scenario and business-as-usual scenario.

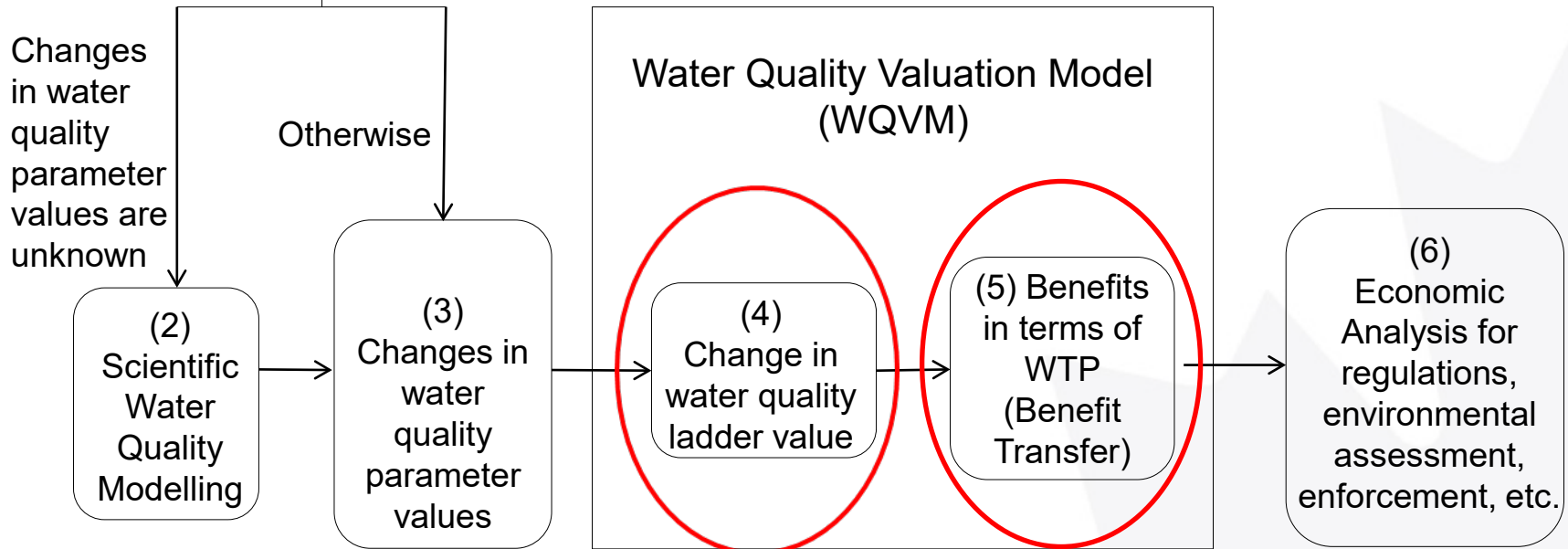

Cost Categories Considered in the Study

Cost Category	Nature of costs imposed
Commercial fishing	Reduced value added due to reduced quality of fish and/or increased costs to harvest fish
Water users: Industries (including municipal drinking water treatment plants)	Increased capital and operating costs due to reduced raw water quality
Recreational users: Individuals that participate in lake-based recreation	Reduced utility due to reduced enjoyment
Non-users: Individuals that do not use the lake but are concerned about its quality	Reduced utility due to reduced well-being associated with knowledge of lake's condition
Tourism: the "tourism industry"	Reduced value added due to lost business
Property owners along the lakeshore	Reduced wealth due to reduced value property



- Three scenarios: Stable Lake, BAU, Policy Intervention
- Relate impact of HNABS to Water Quality
- Monetization
 - Willingness to Pay
 - Direct costs to users





- Definition
- Why is it useful for valuation?

Sources: McClelland 1974;
Vaughan 1986

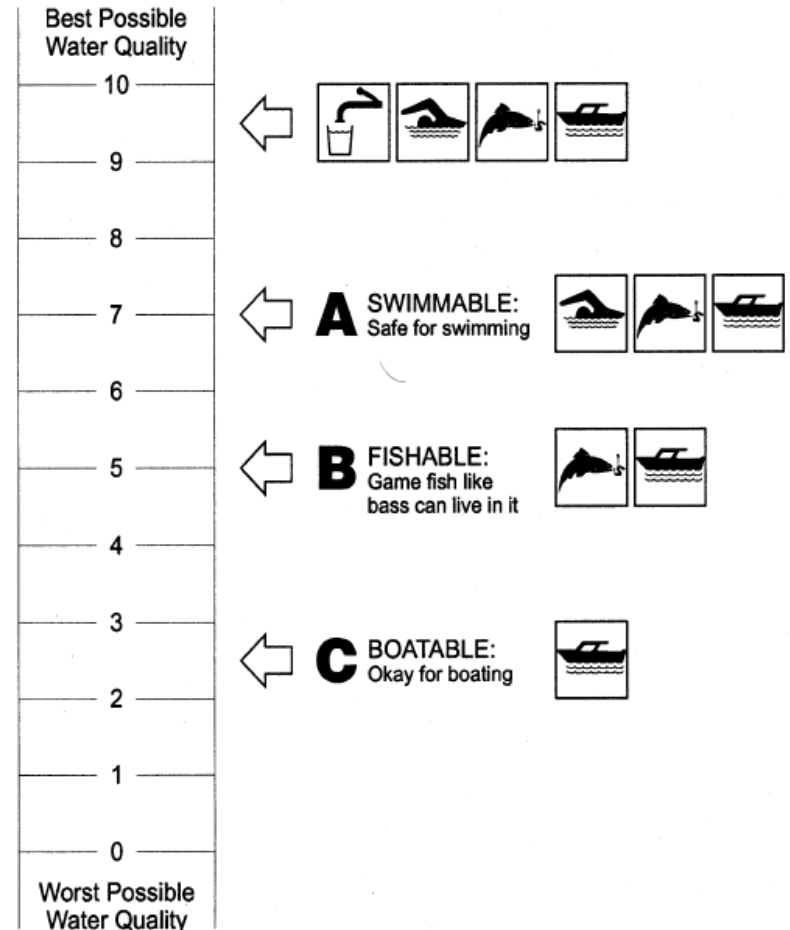

How do we move from



Willingness-to-Pay based on WQL

Source	Non-Boatable to Boatable	Boatable to Fishable	Fishable to Swimmable
User Values	(2014 CAD)		
Average WTP	107.41	64.82	143.98
Minimum WTP	47.40	14.40	2.34
Maximum WTP	234.96	194.43	300.94
Non-User Values	(2014 CAD)		
Average WTP	104.64	81.72	129.52
Minimum WTP	15.14	12.99	21.89
Maximum WTP	241.28	181.62	202.37

Estimated 30-year economic costs of HNABs to the Lake Erie basin

Scenario	Lower bound	Central estimate	Upper bound
	million 2015 dollars		
Stable lake	1,680	2,788	3,206
Business-as-usual scenario	4,076	5,324	5,824
Policy intervention scenario	1,655	2,474	2,782

Estimated Equivalent Annual Economic Costs of HNABs to the Lake Erie Basin

Scenario	Lower bound	Central Estimate	Upper bound
million 2015 dollars			
Stable lake	86	142	164
Business-as-usual	208	272	297
Policy intervention	84	126	142

Public Benefits of BMP Scenario

Summary of the Public Costs and Benefits for the Objective Scenario	40% P. Reduction
Avoided Costs of Phosphorus Water Treatment (\$/Year)	\$12.3 M
Avoided Costs of Nitrogen Water Treatment (\$/Year)	\$30.1 M
Avoided Carbon Emissions Costs (\$/Year)	\$23.4 M
Total Carbon Sequestration Value (\$/Year)	\$118.9 M
Avoided Stormwater Infrastructure Costs (\$/Year)	\$37.6 M
Avoided Flooding Costs (\$/Year)	\$5.7 M
Annual Benefit of Reduced Drought Severity over Sim Period (\$/Year)	-\$0.7 M
Avoided Cost of Soil Erosion Reclamation / Mitigation (\$/Year)	\$7.8 M
Benefit of Improve Biodiversity (\$/Year)	\$90.8 M
Avoided Cost of Algae Blooms (\$/Year)	\$24.6 M
Total Annual Benefit in the Year 2020 (\$/Year)	\$350.4 M

Compare Annual Cost to Benefit

Category	BMP Benefit	Algal Blooms Cost	
• Public	• \$350M	Direct	\$273M
• Total	• \$400M	Direct + Secondary	\$412M
• 30-year	• \$8B	Direct	\$5.3B

Economic impacts are small, but similar to other well-known costs/benefits

- \$272 Million equivalent annual loss in social welfare
- To put this in context



- \$412 M annual loss in spending in the basin economy
 - Impacts on the same order of magnitude as the Gordie Howe Bridge (\$570 M) and the Trans-Mountain Pipeline (\$730 M)

Put this into a global context

Earth Overshoot Day Is Coming Sooner and Sooner

Historical dates of Earth Overshoot Day

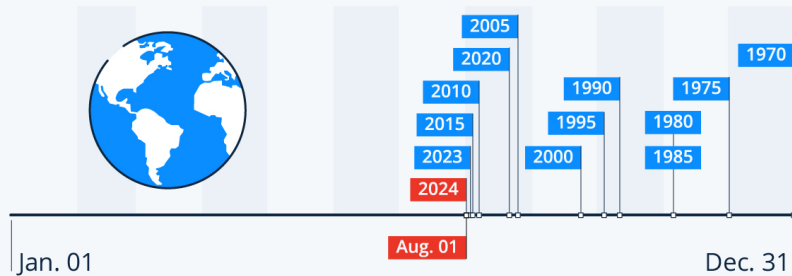

Earth Overshoot Day marks the date when humanity's demand for ecological resources in a given year exceeds what Earth can regenerate in that year.

Source: Earth Overshoot Day



statista

The World Is Not Enough

Number of earths/its resources needed if the world's population lived like the following countries

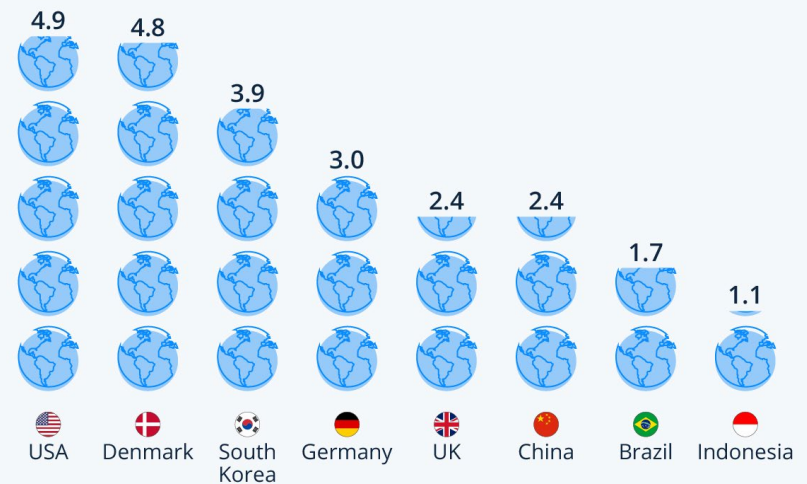

Selected countries. Calculated based on 2022 data estimates

Source: Global Footprint Network



statista

Our demand for ecological resources exceeds capacity to regenerate in one year

Thank you!



Brad Bass

Email: brad.bass@utoronto.ca

Phone: 1 (416) 648-5387